

DW60

Wheel Dumpers



**WACKER
NEUSON**
all it takes!



Heavy duty design offers maximum payload and safe operation

The DW60 combines the power of a hydrostatic transmission Tier 4 Final Perkins engine with an industry leading, heavy duty design. With massive, impact-resistant box sections, this power swivel dumper offers high performance and a bucket engineered for durability. The DW60 is well balanced and easily moves its rated payload across the varying terrains of a job site. Full-time four-wheel drive ensures optimum maneuverability in difficult conditions.

- Operator station is easily accessible from both sides for added convenience. Dash board displays a full range of dials/indicators lights such as fuel gauge, low fuel warning light and parking brake light.
- Hydrostatic drive is easy and intuitive for the operator. The four-wheel drive provides perfect traction in difficult terrain, and articulated steering allows for a tight turning radius
- Swivel bucket allows material to be unloaded on either side of the unit for added versatility
- A top speed of 16mph/25kmh provides for fast cycle times and efficiency
- Awning and cab options available

DW60 Technical specifications

Operating data

Payload	13,228 lb
Shipping weight ROPS	10,886 lb
Shipping weight cabin	11,122 lb
Operating weight ROPS	10,728 lb
Skip capacity - Leveled	3.07 yd ³
Skip capacity - Heaped	4.19 yd ³
Skip capacity - Water	2.17 yd ³

Engine / Motor

Engine / Motor manufacturer	Perkins
Engine / Motor type	854F
Engine / Motor	Watercooled 4-cylinder turbo diesel
Engine performance - ISO 3046/1	73.8 hp
Emission standards stage	3b
Displacement	207.4 in ³
Engine RPM	2500 rpm
Emissions	T4f
Traction drive	4WD, Hydrostatic
Travel speed	15.5 mph
Articulation angle	29 °
Pendulum angle	11 °
Turning radius	236.2 in
Gradeability	50 %
Tires	405/70-20 14PR
L x W x H ROPS	194.3 x 87.8 x 122.4 in
Steering pump	Axial piston pump
Flow rate	40.2 US gpm
Operating pressure	6,527 psi
Duty pump	Gear pump
Flow rate	18 US gpm
Operating pressure	3,481 psi
Fuel tank capacity	21.9 US gal
Hydraulic oil tank	14.5 US gal
Sound level (LwA)	101 dB(A)

DW60 Dimensions

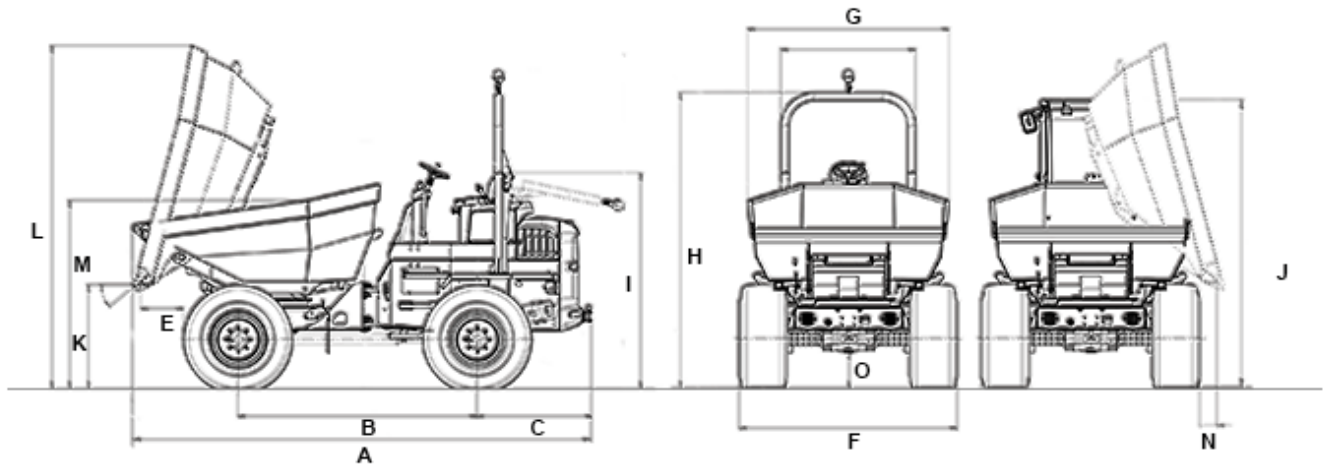

A	Overall length	194.3 in
B	Wheelbase	97.8 in
C	Rear overhang	46.9 in
E	Dumping distance	19.9 in
F	Width	87.8 in
G	Skip width swivel skip	82.3 in
H	Height total (ROPS)	122.4 in
I	Height tilted ROPS	86.1 in
J	Height cabin	117.8 in
K	Dump height max.	46.2 in
L	Skip height tilted	138.7 in
M	Skip height	75 in
N	Dumping distance	4 in
O	Ground clearance	14.5 in
--	Dump angle	48 °

Please note: that product availability can vary from country to country. It is possible that information / products may not be available in your country. More detailed information on engine power can be found in the operator's manual; the stated power may vary due to specific operating conditions. Subject to alterations and errors excepted. Applicable also to illustrations.
Copyright © 2020 Wacker Neuson SE.